

# DURACELL®



## COPPERTOP

# MN1500

## Size: AA (LR6)

### Alkaline-Manganese Dioxide Battery

Zn/MnO<sub>2</sub>

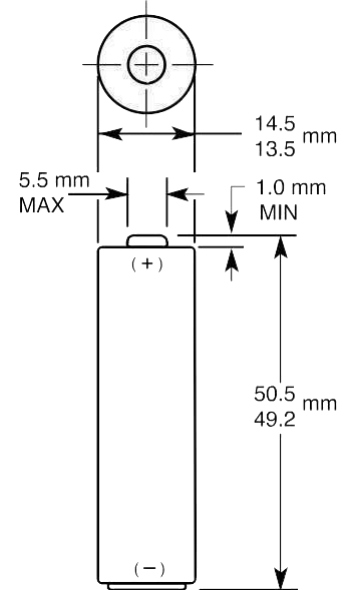

Dimensions shown are IEC standards

Nominal voltage	1.5 V
Impedance	120 m-ohm @ 1 kHz
Typical weight	24 g (0.8 oz)
Typical volume	8.4 cm <sup>3</sup> (0.5 in <sup>3</sup> )
Terminals	Flat
Storage temperature range	5°C to 30°C (41°F to 86°F)
Operating temperature range	-20°C to 54°C (-4°F to 130°F)
Designation	ANSI: 15A IEC: LR6

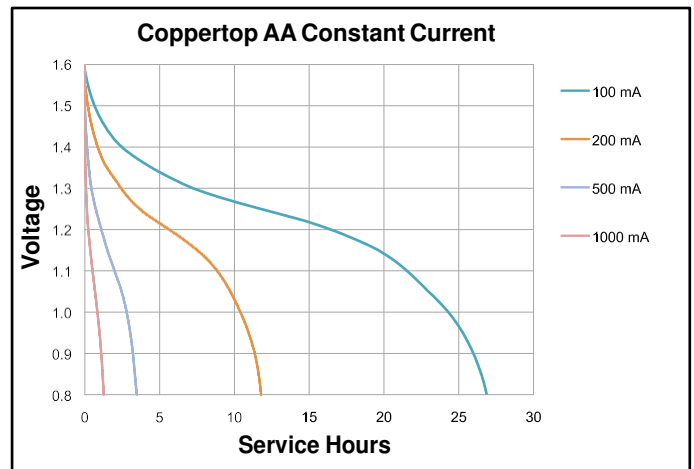
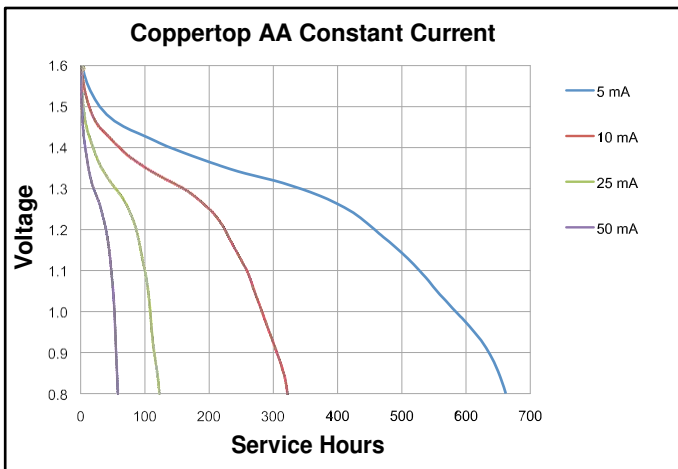

# DURACELL®

BATTERIES

Berkshire Corporate Park  
Bethel, CT. 06801 U.S.A.  
Telephone: Toll-free 1-800-544-5454  
www.duracell.com

Delivered capacity is dependent on the applied load, operating temperature and cut-off voltage. Please refer to the charts and discharge data shown for examples of the energy/service life that the battery will provide for various load conditions.



# MN1500

## Size: AA (LR6)

Alkaline-Manganese Dioxide Battery

Zn/MnO<sub>2</sub>

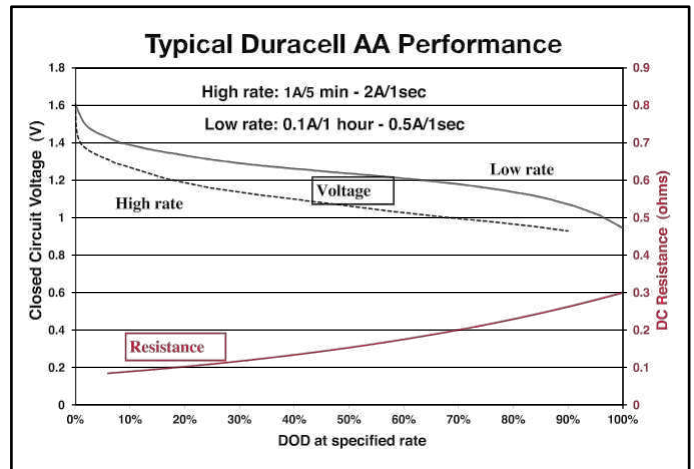
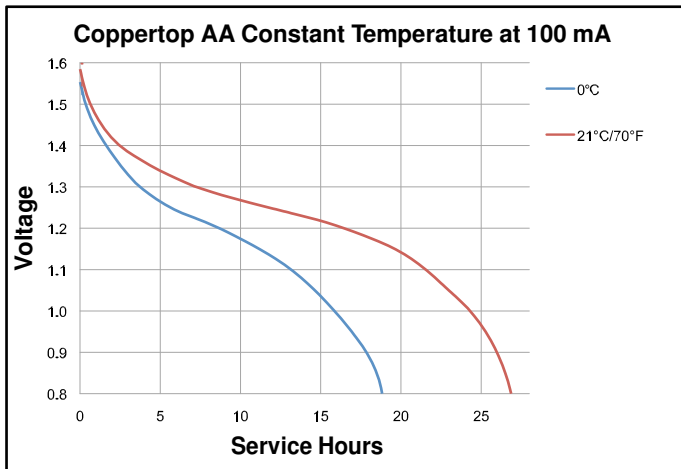
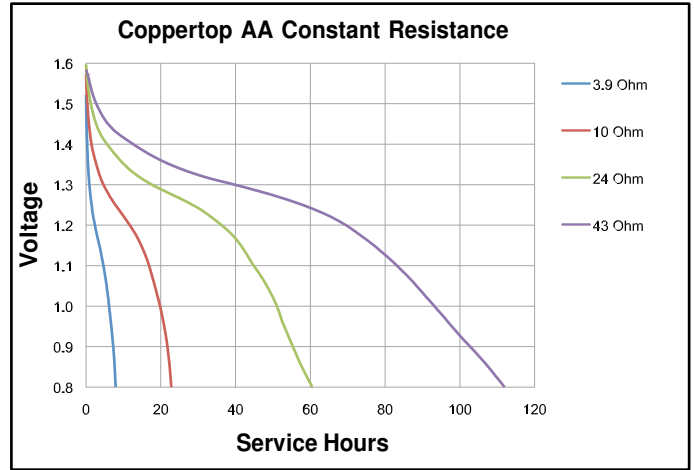
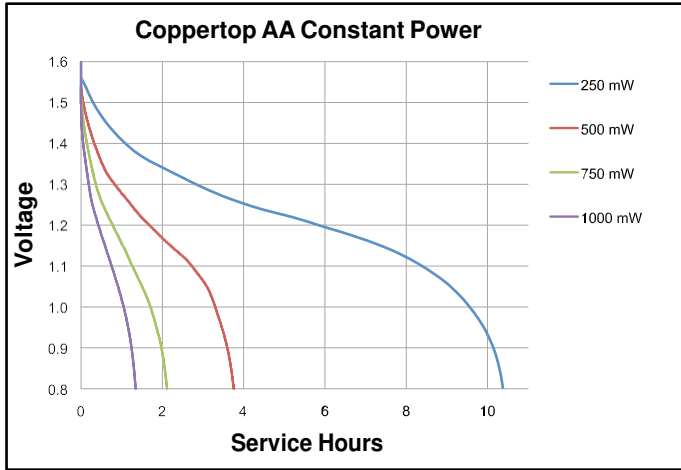

Berkshire Corporate Park  
Bethel, CT. 06801 U.S.A.  
Telephone: Toll-free 1-800-544-5454  
www.duracell.com

Delivered capacity is dependent on the applied load, operating temperature and cut-off voltage. Please refer to the charts and discharge data shown for examples of the energy/service life that the battery will provide for various load conditions.